VAVJE

2022 catalogue

Dr. Hakee

TAIZHOU HANQI LMP.&EXP.TRADING CO.,LTD

📍 Room 425-426 (B1) , International Valve City, Lupu Town,
Yuhuan City, Zhejiang Province,China

✉️ andrew@hakee.net

🌐 www.drhakee.com www.hakee.net

Dr. Hakee



COMPANY PROFILE

Did you know that only 3 % of all water is fresh water and that only 1 % is available for drinking? The extreme effects of climate change will have more negative impact on our planet, like severe floods or prolonged droughts. These events not only can damage water infrastructure, but also affect availability of water. Planet and water saving is extremely important - let's take together important steps to save that 1 % of pure water.

RUBINETA TAKES IMPORTANT ACTIONS TO WATER SUSTAINABILITY

While washing hands, running a bath or using a shower, water often runs longer than needed. Yet water is one of the most valuable resources we have. Rubineta's products are designed to function in an environmentally friendly manner for the entire product life cycle. Touchless faucets, water saving aerators in every our faucet and water saving handshowers - these and more our products create a better tomorrow for our Planet's water resources.

CONTENTS

- 01-19** — BALL VALVES
- 20-24** — BIBCOCKS
- 25-35** — ANGLE VALVES
- 36-39** — FLOAT VALVES
- 40-43** — GATE VALVES
- 44-46** — RADIATOR VALVES
- 47-52** — FITTINGS
- 53-54** — MANIFOLD



Dr. 12101101

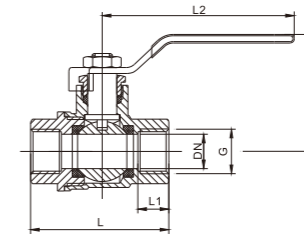

SIZE	G	DN	L	H	L1	L2
1/4"	1/4"	10	41	37	9.5	75
3/8"	3/8"	10	41	37	9.5	75
1/2"	1/2"	15	48	42	11	85
3/4"	3/4"	19	58	46.5	13.5	85
1"	1"	23	68	56.5	15.5	104
1 1/4"	1 1/4"	30	78	69	18.5	120
1 1/2"	1 1/2"	37	88	78	19.5	151
2"	2"	45	102	86.5	21	151
2 1/2"	2 1/2"	62	128	120.5	23.5	225
3"	3"	73	142	128.5	25	225
4"	4"	90	172	145	26	271

Dr. 12101102

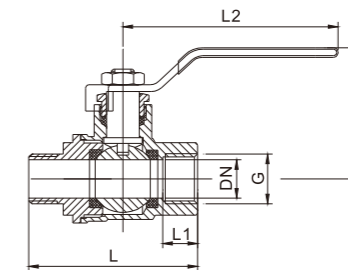
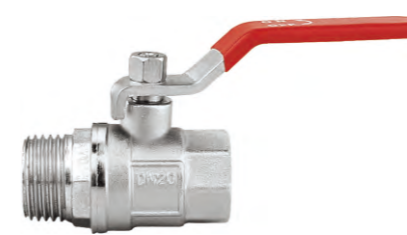

SIZE	G	DN	L	H	L1	L2
1/2"	1/2"	14.5	50	50	16	82
3/4"	3/4"	19	50	50	18.5	97
1"	1"	24	57.5	57.5	21	112
1 1/4"	1 1/4"	32	83.5	83.5	22.5	120
1 1/2"	1 1/2"	39.5	88.5	88.5	22.5	156.5
2"	2"	49	96	96	27	156.5

Dr. 12101103

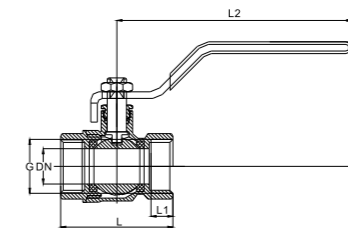

SIZE	G	DN	L	H	L1	L2
1/2"	1/2"	14	49	46.5	10.5	96
3/4"	3/4"	19	56.5	52	11.5	96
1"	1"	23	67	60	14	127
1 1/4"	1 1/4"	30	78	66	13.5	127
1 1/2"	1 1/2"	37	83	79	14.5	137
2"	2"	46	97	96	15.5	167

Dr. 12101104

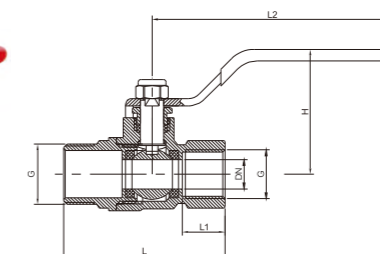

SIZE	G	DN	L	H	L1	L2
1/2"	1/2"	14	54	52	10.5	96
3/4"	3/4"	19	64.3	52	11.5	96
1"	1"	24.5	69	61	14	105
1 1/4"	1 1/4"	30.5	82.5	74	13.5	136
1 1/2"	1 1/2"	37	95.2	81	14.5	136
2"	2"	45	110.3	93	15.5	155

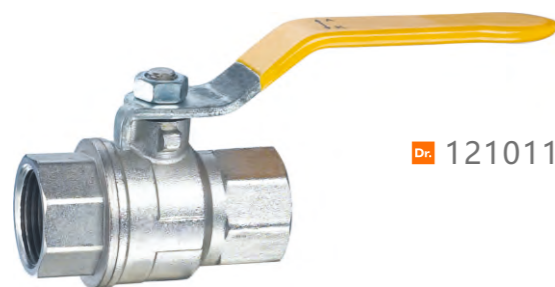
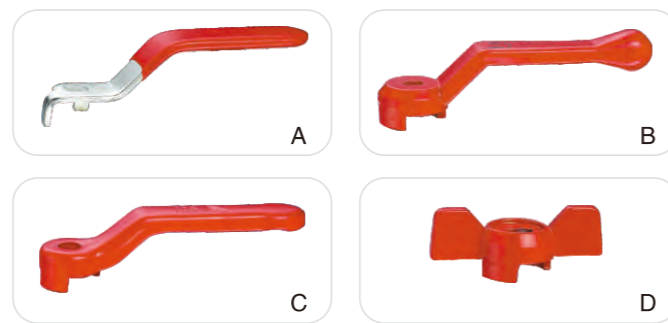
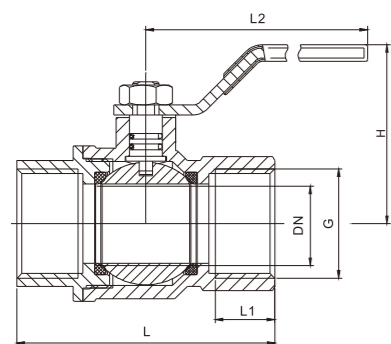

Dr. 12101100

SIZE	G	DN	L	H	L1	L2
1/2"	1/2"	15	59	40.5	15	103
3/4"	3/4"	19	68	50.5	17	113
1"	1"	24	78	54	18.5	113
1 1/4"	1 1/4"	32	96	66	22	137
1 1/2"	1 1/2"	40	104	72.5	22	177
2"	2"	49	125.5	84.4	27	177

Dr. 12101105

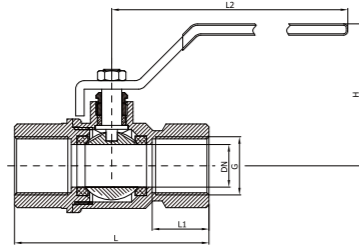

SIZE	G	DN	L	H	L1	L2
1/2"	1/2"	15	71.5	48.5	10.5	95
3/4"	3/4"	20	79.3	58	11	113
1"	1"	24.5	85	60.5	12	113
1 1/4"	1 1/4"	32	107.5	73.6	14	157
1 1/2"	1 1/2"	40	117.5	82	16	165
2"	2"	50	138	88	17	165

Dr. 12101106

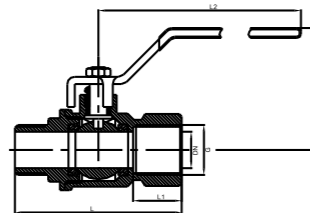

SIZE	G	DN	L	H	L1	L2
1/2"	1/2"	15	71.5	48.5	10.5	95
3/4"	3/4"	20	79.3	58	11	113
1"	1"	24.5	85	60.5	12	113
1 1/4"	1 1/4"	32	107.5	73.6	14	157
1 1/2"	1 1/2"	40	117.5	82	16	165
2"	2"	50	138	88	17	165

Dr. 12101107

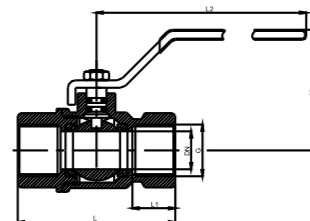

SIZE	G	DN	L	H	L1	L2
1/2"	1/2"	14.5	48.5	46	11.5	99
3/4"	3/4"	19	54.2	49.5	11.5	99
1"	1"	23	66	60	14	108
1 1/4"	1 1/4"	30	79	68.5	15	137
1 1/2"	1 1/2"	37	87.5	73.5	16	137
2"	2"	46	107	92.5	19	146

Dr. 12101108

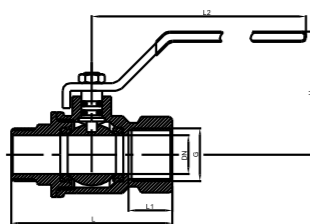
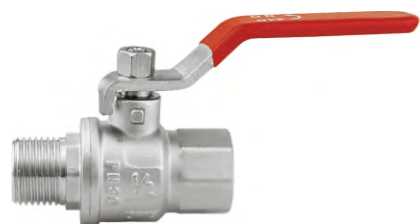

SIZE	G	DN	L	H	L1	L2
1/2"	1/2"	14.5	48.5	46	11.5	99
3/4"	3/4"	19	54.2	49.5	11.5	99
1"	1"	23	66	60	14	108
1 1/4"	1 1/4"	30	79	68.5	15	137
1 1/2"	1 1/2"	37	87.5	73.5	16	137
2"	2"	46	107	92.5	19	165

Dr. 12101109

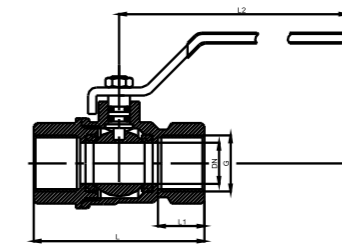

SIZE	G	DN	L	H	L1	L2
1/2"	1/2"	14	46	45.5	10	96
3/4"	3/4"	19	51	51	10	96
1"	1"	23	60.5	61	13.5	113
1 1/4"	1 1/4"	30	71	67.5	13.5	113
1 1/2"	1 1/2"	37	78	78.5	15	139
2"	2"	45	93.5	89	16	167
2 1/2"	2 1/2"	54	124	109	23	245
3"	3"	70	144	120	25	245
4"	4"	85	166	130	25	245

Dr. 12101110

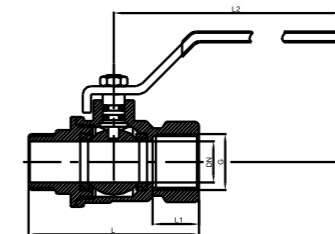

SIZE	G	DN	L	H	L1	L2
1/2"	1/2"	14	46	45.5	10	96
3/4"	3/4"	19	51	51	10	96
1"	1"	23	60.5	61	13.5	113
1 1/4"	1 1/4"	30	71	67.5	13.5	113
1 1/2"	1 1/2"	37	78	78.5	15	139
2"	2"	45	93.5	89	16	167
2 1/2"	2 1/2"	54	124	109	23	245
3"	3"	70	144	120	25	245
4"	4"	85	166	130	25	245

Dr. 12101111

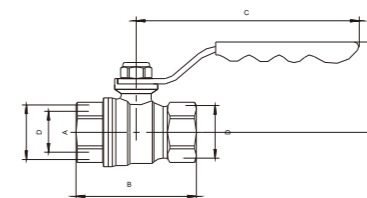

SIZE	A	B	C	D	E	F
1/2"	15	55	103.5	1/2"	42.5	
3/4"	19	59.3	103.5	3/4"	46.5	
1"	24	73	110	1"	52.5	

Dr. 12101112

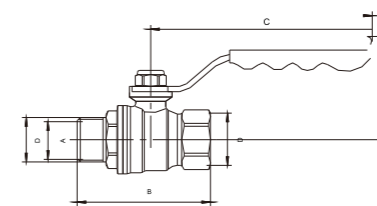

SIZE	A	B	C	D	E	F
1/2"	15	61.5	103.5	1/2"	42.5	
3/4"	19	65.3	103.5	3/4"	46.5	
1"	24	78.5	110	1"	52.5	

Dr. 12101113

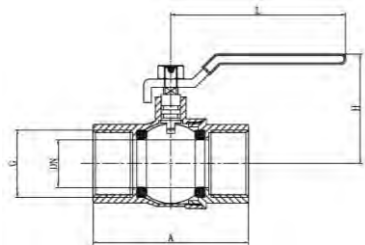

SIZE	G	DN	L	H	L1	L2
1/4"	49	30	75	1/4"	8	
3/8"	98	31	86	3/8"	10	
1/2"	59	39	86	1/2"	15	
3/4"	71.5	43	103	3/4"	20	
1"	82	51.5	118	1"	25	
1 1/4"	98	67	112	1 1/4"	32	
1 1/2"	105.5	72	150	1 1/2"	40	
2"	124.5	78	150	2"	50	

/mm

Dr. 12101114

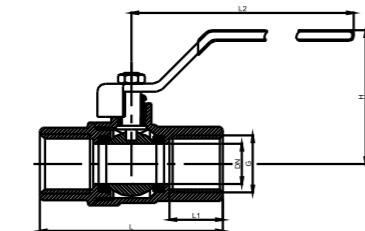

SIZE	G	DN	L	H	L1	L2
1/2"	1/2"	14.5	62.5	50	17.5	90
3/4"	3/4"	20	71.5	56	20	102
1"	1"	25	79	62	20	102
1 1/4"	1 1/4"	32	82	71	20	120
1 1/2"	1 1/2"	38	90	84	20	146
2"	2"	45	109	94	23.5	146

/mm

Dr. 12101115

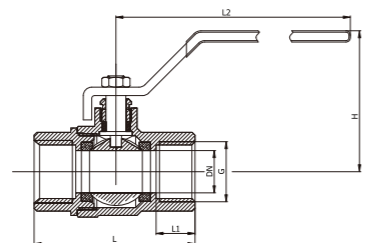

SIZE	G	DN	L	H	L1	L2
1/2"	1/2"	15	63	49	17	92
3/4"	3/4"	19	72	53	19	104
1"	1"	25	80	60	18	104
1 1/2"	1 1/2"	38	90	86	18	147
2"	2"	45	109	90	23	147

/mm

Dr. 12101116

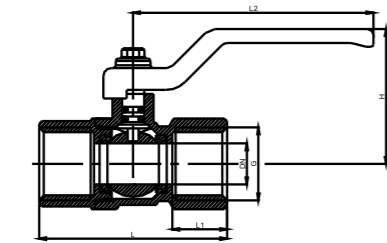
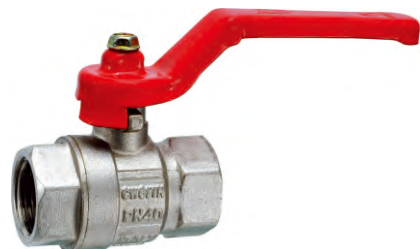

SIZE	G	DN	L	H	L1	L2
1/2"	1/2"	14.5	46.3	45.5	11	80
3/4"	3/4"	19	57	54.5	12	100
1"	1"	24	66.5	58	15	100
1 1/4"	1 1/4"	30.5	77	68.5	16	114
1 1/2"	1 1/2"	37	86.5	87.5	17	142
2"	2"	47	100	96	18	142

/mm

Dr. 12101117

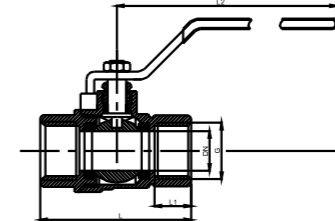

SIZE	G	DN	L	H	L1	L2
1/2"	1/2"	15	49	47	10	101
3/4"	3/4"	20	60	53.5	11	101
1"	1"	24	64	58	13.5	110
1 1/4"	1 1/4"	30	73	76	13.5	110
1 1/2"	1 1/2"	37	83.5	81	15	137
2"	2"	46	97	95	16	165
2 1/2"	2 1/2"	62	128	114	21.5	221
3"	3"	73	146	122	24.5	221
4"	4"	85	167	131	26.5	221

/mm

Dr. 12101118

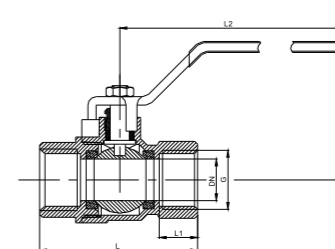

SIZE	G	DN	L	H	L1	L2
1/2"	1/2"	15	49	47	10	101
3/4"	3/4"	20	60	53.5	11	101
1"	1"	24	64	58	13.5	110
1 1/4"	1 1/4"	30	73	76	13.5	110
1 1/2"	1 1/2"	37	83.5	81	15	137
2"	2"	46	97	95	16	165
2 1/2"	2 1/2"	62	128	114	21.5	221
3"	3"	73	146	122	24.5	221
4"	4"	85	167	131	26.5	221

/mm

Dr. 12101119

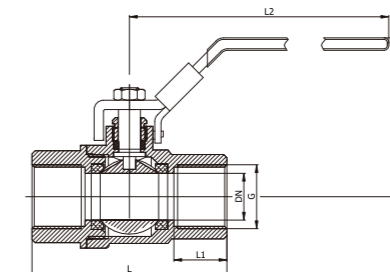

SIZE	G	DN	L	H	L1	L2
1/4"	1/4"	10	55	52	11	104
3/8"	3/8"	12	56.5	52	15	104
1/2"	1/2"	15	62.5	56	17	112
3/4"	3/4"	20	70	59	18	112
1"	1"		79.5	65	21	117
1 1/4"	1 1/4"	32	82	70	23	117
1 1/2"	1 1/2"	37	104	85	25	141

/mm

Dr. 12101120

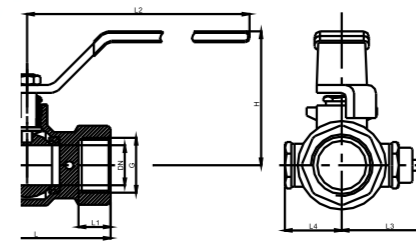

SIZE	G	DN	L	H	L1	L2
1/2"	1/2"	14.5	54.5	53.4	12	100
3/4"	3/4"	19	59.5	57	12	100
1"	1"	24.5	67.5	65	13.5	114
1 1/4"	1 1/4"	32	82	73	14.5	122
1 1/2"	1 1/2"	40	91	92	16.5	142
2"	2"	50	110	100	19.5	142

/mm

Dr. 12101121

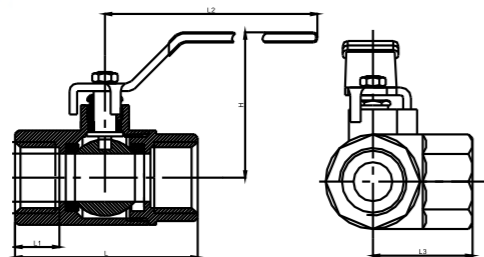

SIZE	G	DN	L	H	L1	L2
1/2"	1/2"	15	59.4	45.5	12	85
3/4"	3/4"	19	64	48.5	12	85
1"	1"	25	82	61	14	97

/mm

Dr. 12101125

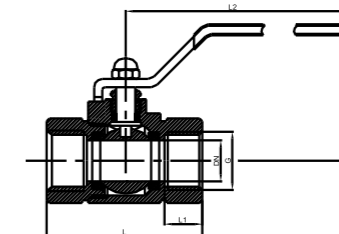

SIZE	G	DN	L	H	L1	L2
1/2"	1/2"	12.5	50	50	12	90
3/4"	3/4"	14.5	52	52	12	90
1"	1"	17.5	61	54	14	105
1 1/4"	1 1/4"	23.5	71	64	15	119
1 1/2"	1 1/2"	25	81	65	19	119
2"	2"	32	87	75	17	147

/mm

Dr. 12101122

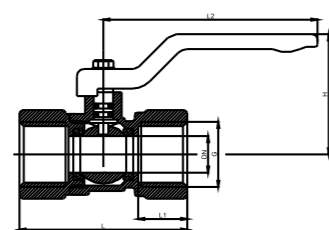

SIZE	G	DN	L	H	L1	L2
1/2"	1/2"	10	46.8	31	10	80
3/4"	3/4"	14.5	50	36	10	80
1"	1"	19	62	47	13.5	85
1 1/4"	1 1/4"	25	69.3	52.5	13.5	100
1 1/2"	1 1/2"	30.5	75.5	57	15	100
2"	2"	33	86.5	63	16	133

/mm

Dr. 12101126

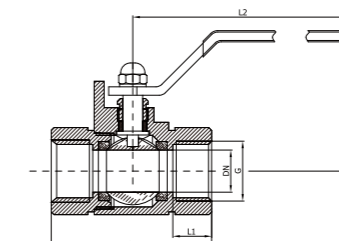

SIZE	G	DN	L	H	L1	L2
1/2"	1/2"	12	57	42	21	86
3/4"	3/4"	15	72	46	20	105
1"	1"	19	83	53	23	113

/mm

Dr. 12101123

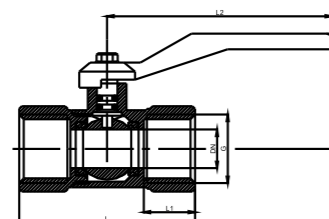

SIZE	G	DN	L	H	L1	L2
1/2"	1/2"	12	46.5	40	10	86
3/4"	3/4"	14	49.5	42.5	11	86
1"	1"	19	61	51	13.5	110
1 1/4"	1 1/4"	25	69	59	14.5	110
1 1/2"	1 1/2"	30	80	68	16.5	142
2"	2"	38	92	75	18.5	142
2 1/2"	2 1/2"	49	111	83.5	20.5	163
3"	3"	57	124	99.5	20.5	223
4"	4"	70	151	115	23.5	223

/mm

Dr. 12101127

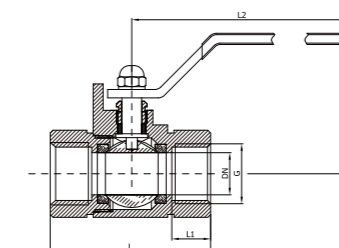

SIZE	G	DN	L	H	L1	L2
1/2"	1/2"	15	57	45	13.5	102
3/4"	3/4"	15	60	45	13.5	102
1"	1"	19	63	50	15	102

/mm

Dr. 12101124

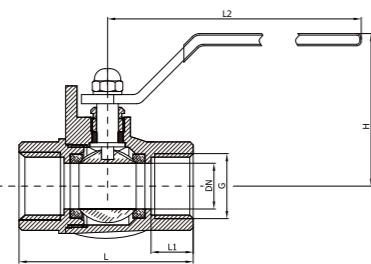

SIZE	G	DN	L	H	L1	L2
1/2"	1/2"	14	53	41	13	83
3/4"	3/4"	19	59	48	13	101
1"	1"	28	70	60	16	111

/mm

Dr. 12101128

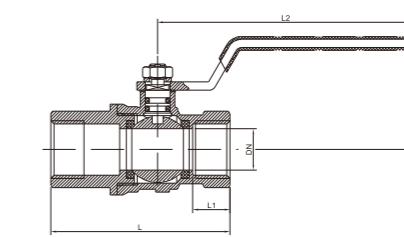

SIZE	G	DN	L	H	L1	L2
1/2"	1/2"	17.5	65	41	13.5	93
3/4"	3/4"	19.5	67	43	13.5	93
1"	1"	22.2	76	45	12.5	108
1 1/4"	1 1/4"	28.2	86	55	13.5	122
1 1/2"	1 1/2"	30	96	56	17.5	122
2"	2"	37	102	66	15.5	150

/mm

Dr. 12101129

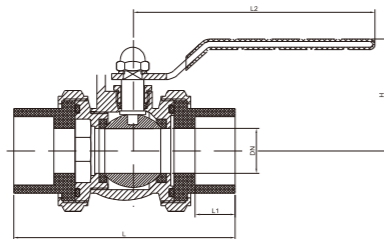

SIZE	DN	L	H	L1	L2
1/2"	10	76.5	38	16	77
3/4"	14	82	44	17	86
1"	30	90	48	21	100
1 1/4"	24.5	110	60	23	100
1 1/2"	30	129	65	25	142
2"	37	50	68	28	142

Dr. 12101130

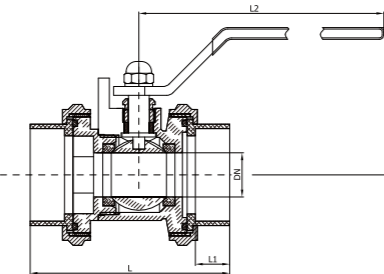

SIZE	DN	L	H	L1	L2
1/2"	10	76.5	38	16	77
3/4"	14	82	44	17	86
1"	30	90	48	21	100
1 1/4"	24.5	110	60	23	100
1 1/2"	30	129	65	25	142
2"	37	50	68	28	142

Dr. 12101131

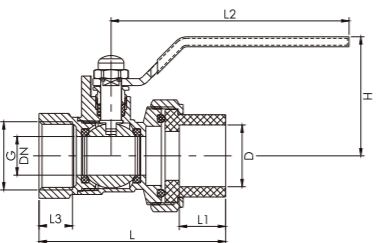

SIZE	G	DN	D	L	H	L1	L2	L3
20x1/2"	1/2"	12	19	65	42	16	85	12
25x3/4"	3/4"	15	24	72.5	48.5	18	95	13
32x1"	1"	18	30	85	62	20	105	15

Dr. 12101132

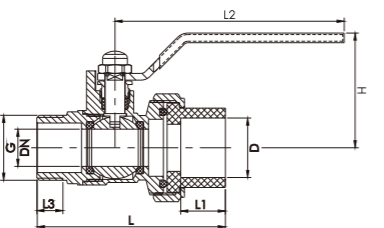

SIZE	G	DN	D	L	H	L1	L2	L3
20mm	1/2"	12	19	68	42	16	85	10
25mm	3/4"	15	24	76	48.5	18	95	10.5
32mm	1"	19	30.5	83.5	52.5	20	105	11.5

Dr. 12101133

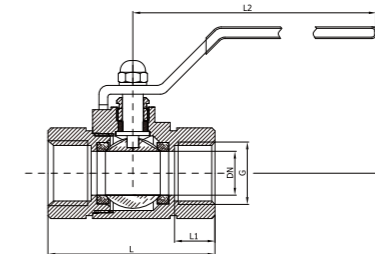
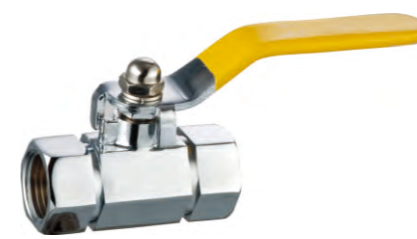

SIZE	G	DN	L	H	L1	L2
1/2"	1/2"	12.5	50	50	12	90
3/4"	3/4"	14.5	52	52	12	90
1"	1"	17.5	61	54	14	105
1 1/4"	1 1/4"	23.5	71	64	15	119
1 1/2"	1 1/2"	25	81	65	19	119
2"	2"	32	87	75	17	147

Dr. 12101134

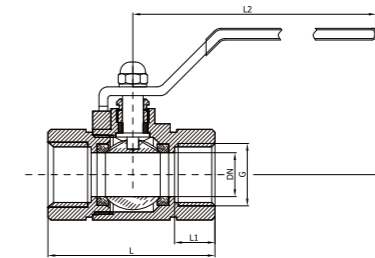

SIZE	G	DN	L	H	L1	L2
1/2"	1/2"	12	61	44	17	92
3/4"	3/4"	15	63	49	17	92
1"	1"	19	71	57	18	105

Dr. 12101135

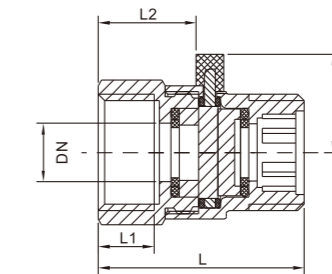

SIZE	DN	L	H	L1	L2
1/2"	9.5	40.5	22	11	16

Dr. 12101136

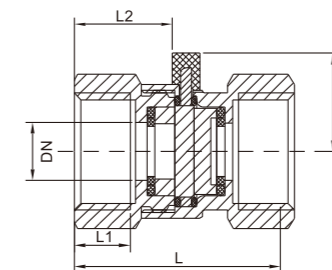

SIZE	DN	L	H	L1	L2
1/2"	9.5	40.5	22	11	16

Dr. 12101137

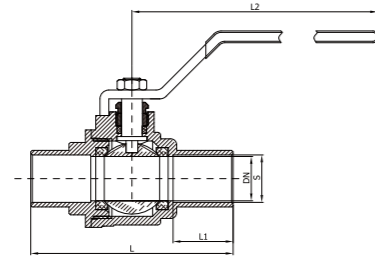

SIZE	S	DN	L	H	L1	L2
15mm	15	14	73.5	52	12	83
18mm	18	14	73.5	52	12	83
22mm	22	19	84.5	55	12	101
28mm	28	23.5	98	61	12	133

Dr. 12101138

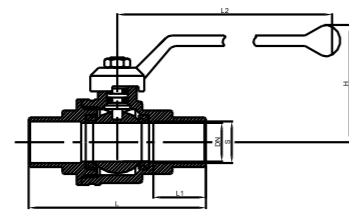

SIZE	S	DN	L	H	L1	L2
15mm	15	14	73.5	52	12	83
18mm	18	14	73.5	52	12	83
22mm	22	19	84.5	55	12	101
28mm	28	23.5	98	61	12	133

Dr. 12101139

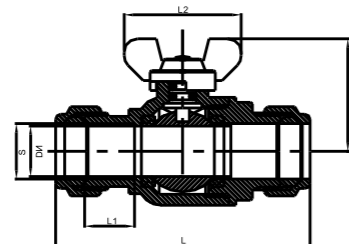

SIZE	S	DN	L	H	L1	L2
15mm	15	14	75	43	12	54
22mm	22	20	83	46	12	54
28mm	28	25	95	56	12	76
35mm	35	32	121	61	12	76

Dr. 12101140

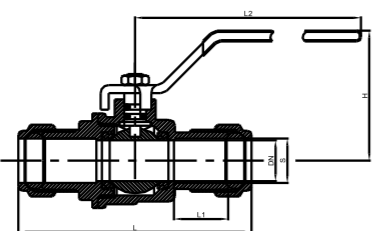

SIZE	S	DN	L	H	L1	L2
15mm	15	14	75	41	12	84
22mm	22	20	93	45	12	84
28mm	28	25	93	54	12	120
35mm	35	32	108.5	60	12	120
42mm	42	40	119.5	76	14	163
54mm	54	50	138.5	130	16	163

Dr. 12101141

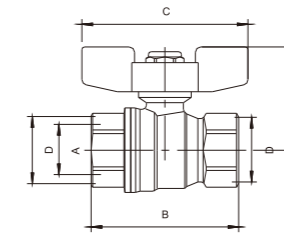

SIZE	A	B	C	D	E	F
1/2"	15	55	63	1/2"	36.5	
3/4"	19	59.3	72.5	3/4"	41	
1"	24	73	72.5	1"	46	

Dr. 12101142

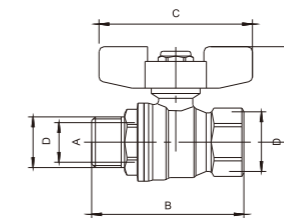

SIZE	A	B	C	D	E	F
1/2"	15	61.5	63	1/2"	36.5	
3/4"	19	65.5	72.5	3/4"	41	
1"	24	78.5	72.5	1"	46	

Dr. 12101143

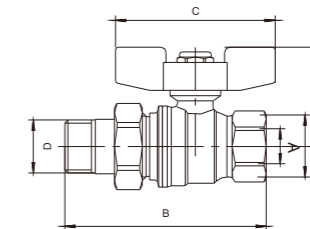

SIZE	A	B	C	D	E	F
1/2"	15	79	63	1/2"	36.5	
3/4"	19	86	72.5	3/4"	41	

Dr. 12101144

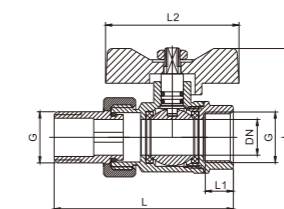

SIZE	G	DN	L	H	L1	L2
1/2"	1/2	14.5	38.5	67	13	57
3/4"	3/4	19	41.5	88	14.5	57
1"	1	23	50.5	99	15	68
1 1/4"	1 1/4	32	57	105.5	16.8	68

Dr. 12101145

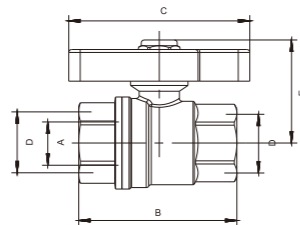

SIZE	A	B	C	D	E	F
1/2"	15	55	63	1/2"	35.7	
3/4"	19	58.3	72	3/4"	41.5	
1"	24	72	72	1"	46	

Dr. 12101146

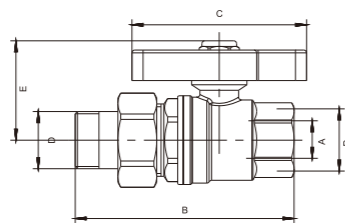
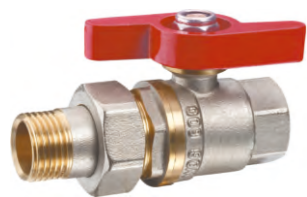

SIZE	A	B	C	D	E	F
1/2"	15	82.5	63	1/2"	35.7	
3/4"	19	92.5	72	3/4"	41.5	
1"	24	109.5	72	1"	46	

Dr. 12101147

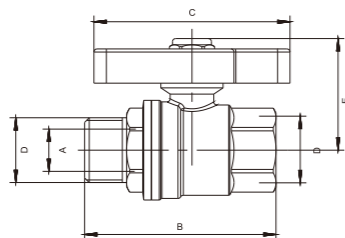
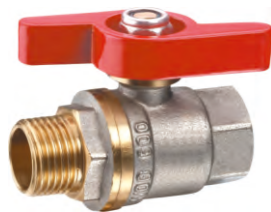

SIZE	A	B	C	D	E	F
1/2"	15	61.5	63	1/2"	35.7	
3/4"	19	64.5	72	3/4"	41.5	
1"	24	77.5	72	1"	46	

Dr. 12101148

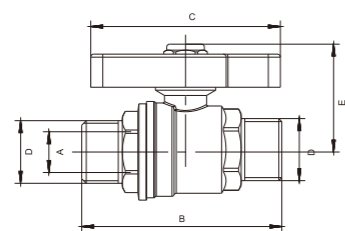

SIZE	A	B	C	D	E	F
1/2"	15	66.5	63	1/2"	35.7	
3/4"	19	68	72	3/4"	41.5	

Dr. 12101149

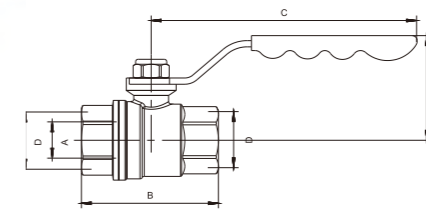

SIZE	A	B	C	D	E	F
1/2"	15	55	99.5	1/2"	42.5	
3/4"	19	58.5	103.5	3/4"	46.5	
1"	24	72	107	1"	52.5	
1 1/4"	32	85.5	107	1 1/4"	60.5	
1 1/2"	32	96	143.5	1 1/2"	69	
2"	40	108.5	167.5	2"	81.3	

Dr. 12101150

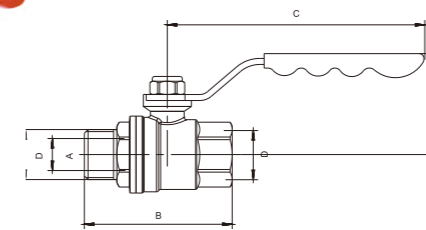

SIZE	A	B	C	D	E	F
1/2"	15	61.5	99.5	1/2"	42.5	
3/4"	19	64.5	103.5	3/4"	46.5	
1"	24	77.5	107	1"	52.5	
1 1/4"	32	92.5	107	1 1/4"	60.5	
1 1/2"	32	104	143.5	1 1/2"	69	
2"	40	116.5	167.5	2"	81.3	

Dr. 12101151

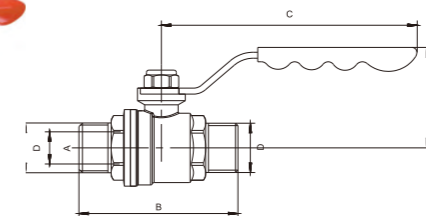

SIZE	A	B	C	D	E	F
1/2"	15	66.5	99.5	1/2"	42.5	
3/4"	19	68	103.5	3/4"	46.5	

Dr. 12101152

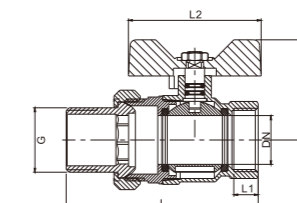

SIZE	G	DN	L	H	L1	L2
1/2"	1/2	15	72	42	9.5	54
3/4"	3/4	20	89	45.5	11	54
1"	1	25	100	51.3	12.5	68

Dr. 12101153

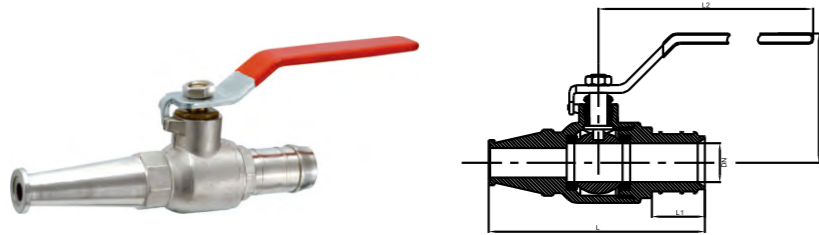

SIZE	DN	L	H	L2
1/2"	10	133	53	110

Dr. 12101154

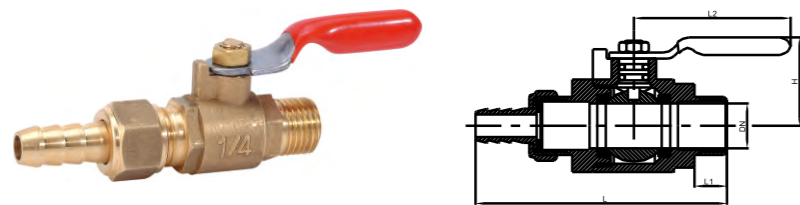

SIZE	DN	L	H	L1	L2
1/2"	8	67	26	10	49

Dr. 12101155



SIZE	G	DN	L	H	L1	L2
1/4"	1/4"	6	42.5	27	13	23.5
3/8"	3/8"	8	42.5	28.1	12	23.5
1/2"	1/2"	10	45.5	43	11	23.5

Dr. 12101156



SIZE	G	DN	L	H	L1	L2
1/4"	1/4"	6	41.5	27	10	23.5
3/8"	3/8"	8	41.5	28.1	10	23.5
1/2"	1/2"	10	44	31.1	11	23.5

Dr. 12101157



SIZE	G	DN	L	H	L2
1/2"	1/2"	9	55	32.5	34.5

Dr. 12101158



SIZE	G	DN	L	H	L1	L2
1/4"	1/4"	6	38	26.5	8.5	20
3/8"	3/8"	8	38	26.5	8.5	20
1/2"	1/2"	10	45	30	12	20

Dr. 12101159



SIZE	G	DN	L	H	L1
1/4"	1/4"	φ8	38.5	26.5	9
3/8"	3/8"	φ8	38.5	26.5	9
1/2"	1/2"	φ10	45.5	31	8

Dr. 12101160

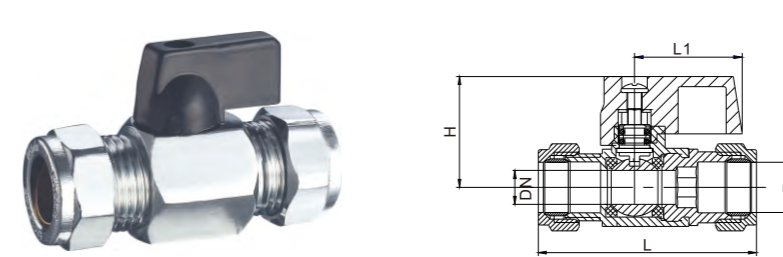

SIZE	D	DN	L	H	L1
15mm	15	10	59	27	21



Dr. 12101161

SIZE: 15x15x $\frac{1}{2}$ "

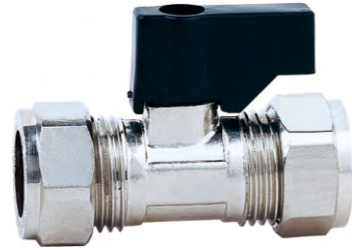

Dr. 12101162

SIZE: 15mm

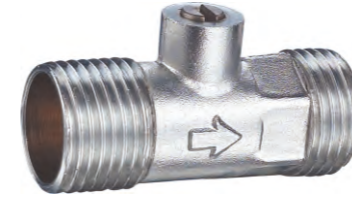

Dr. 12101169

SIZE: $\frac{1}{2}$ "



Dr. 12101170

SIZE: 15mmx15mm



Dr. 12101163

SIZE: 15x $\frac{1}{2}$ "

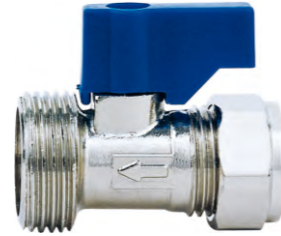

Dr. 12101164

SIZE: 15x $\frac{1}{2}$ "



Dr. 12101171

SIZE: 15mmx15mm



Dr. 12101172

SIZE:
6.5mmx15mm
8.5mmx15mm
8.5mmx22mm



Dr. 12101165

SIZE: 15mmx15mmx15mm



Dr. 12101166

SIZE: $\frac{1}{2}$ " x $\frac{1}{2}$ " x $\frac{1}{2}$ "



Dr. 12101173

SIZE: 15mmx15mm



Dr. 12101174

SIZE: 15x $\frac{1}{2}$ " 22x $\frac{3}{4}$ "



Dr. 12101167

SIZE: $\frac{1}{2}$ " x $\frac{3}{4}$ "



Dr. 12101168

SIZE: $\frac{1}{2}$ " x $\frac{3}{4}$ "



Dr. 12101175

SIZE: 15mmx15mm



Dr. 12101176

SIZE: 15x $\frac{1}{2}$ " 22x $\frac{3}{4}$ "

Dr. 12101177

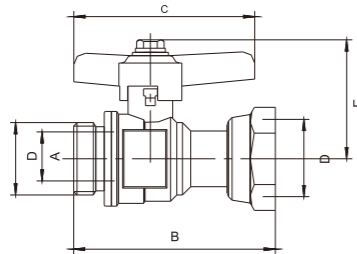

SIZE	A	B	C	D	E	F
3/4"	15	72	65	3/4"	31.2	

Dr. 12101178

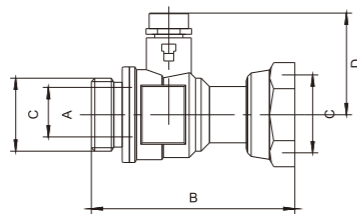

SIZE	A	B	C	D	E	F
3/4"	15	72	65	3/4"	37	

Dr. 12101179

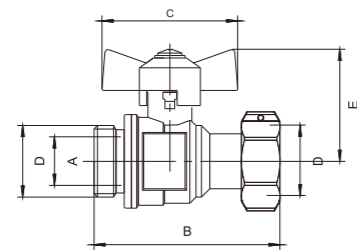

SIZE	A	B	C	D	E	F
3/4"	14.5	70	53	3/4"	41	

Dr. 12101180

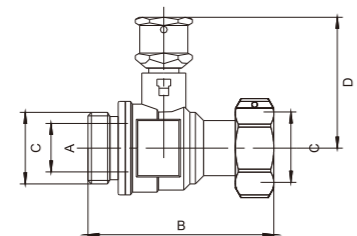

SIZE	A	B	C	D	E	F
3/4"	14.5	70	3/4"	48	41	





Dr. 12302101

SIZE: $\frac{1}{2}$ " $\frac{3}{4}$ " 1"



Dr. 12302102

SIZE: $\frac{1}{2}$ " $\frac{3}{4}$ " 1"

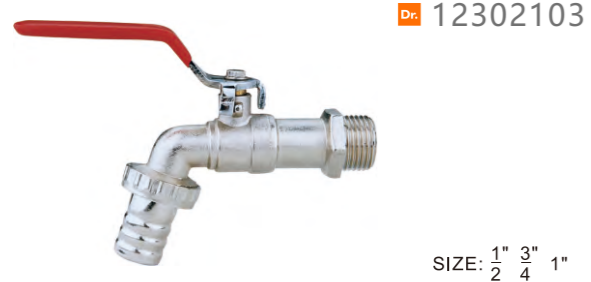

Dr. 12302103

SIZE: $\frac{1}{2}$ " $\frac{3}{4}$ " 1"



Dr. 12302104

SIZE: $\frac{1}{2}$ " $\frac{3}{4}$ " 1"



Dr. 12302105

SIZE: $\frac{1}{2}$ " $\frac{3}{4}$ " 1"

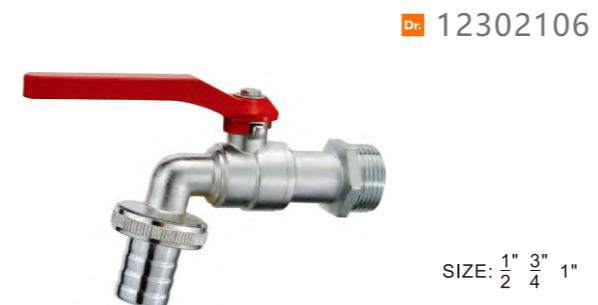

Dr. 12302106

SIZE: $\frac{1}{2}$ " $\frac{3}{4}$ " 1"



Dr. 12302107

SIZE: $\frac{1}{2}$ " x $\frac{3}{4}$ "



Dr. 12302108

SIZE: $\frac{1}{2}$ " x $\frac{3}{4}$ "



Dr. 12302109

SIZE: $\frac{1}{2}$ " $\frac{3}{4}$ "



Dr. 12302110

SIZE: $\frac{1}{2}$ "



Dr. 12302111

SIZE: $\frac{1}{2}$ " $\frac{3}{4}$ "



Dr. 12302112

SIZE: $\frac{1}{2}$ "

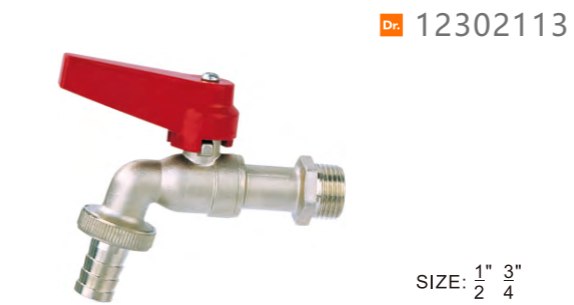

Dr. 12302113

SIZE: $\frac{1}{2}$ " $\frac{3}{4}$ "



Dr. 12302114

SIZE: $\frac{1}{2}$ " $\frac{3}{4}$ "



Dr. 12302115

SIZE: $\frac{1}{2}$ "



Dr. 12302116

SIZE: $\frac{1}{2}$ "



Dr. 12302117

SIZE: $\frac{1}{2}$ " $\frac{3}{4}$ "



Dr. 12302118

SIZE: $\frac{1}{2}$ " $\frac{3}{4}$ "



Dr. 12302119

SIZE: $\frac{1}{2}$ " $\frac{3}{4}$ "



Dr. 12302120

SIZE: $\frac{1}{2}$ "



Dr. 12302121

SIZE: $\frac{1}{2}$ "



Dr. 12302122

SIZE: $\frac{1}{2}$ "



Dr. 12302123

SIZE: $\frac{1}{2}$ " $\frac{3}{4}$ "



Dr. 12302124

SIZE: $\frac{1}{2}$ " $\frac{3}{4}$ "



Dr. 12302125

SIZE: $\frac{1}{2}$ "



Dr. 12302126

SIZE: $\frac{1}{2}$ "



Dr. 12302127

SIZE: $\frac{1}{2}$ "



Dr. 12302128

SIZE: $\frac{1}{2}$ "



Dr. 12302129

SIZE: $\frac{1}{2}$ "



Dr. 12302130

SIZE: $\frac{1}{2}$ "



Dr. 12302131

SIZE: $\frac{1}{2}$ "



Dr. 12302132

SIZE: $\frac{1}{2}$ "

ANGLE VALVES



Dr. 12203101

SIZE: $\frac{1}{2} \times \frac{3}{8}$ $\frac{1}{2} \times \frac{1}{2}$ $\frac{1}{2} \times \frac{3}{4}$



Dr. 12203102

SIZE: $\frac{1}{2} \times 10\text{mm}$



Dr. 12203103

SIZE: $\frac{1}{2} \times \frac{3}{8}$ $\frac{1}{2} \times \frac{1}{2}$ $\frac{1}{2} \times \frac{3}{4}$



Dr. 12203104

SIZE: $\frac{1}{2} \times 10\text{mm}$



Dr. 12203105

SIZE: $\frac{1}{2} \times \frac{1}{2}$ $\frac{1}{2} \times \frac{3}{4}$



Dr. 12203106

SIZE: $\frac{1}{2} \times \frac{3}{8}$ $\frac{1}{2} \times \frac{1}{2}$ $\frac{1}{2} \times \frac{3}{4}$



Dr. 12203107

SIZE: $\frac{1}{2} \times 10\text{mm}$



Dr. 12203108

SIZE: $\frac{1}{2} \times \frac{1}{2}$ $\frac{1}{2} \times \frac{3}{4}$



Dr. 12203109

SIZE: $\frac{1}{2} \times \frac{3}{8}$ $\frac{1}{2} \times \frac{1}{2}$



Dr. 12203110

SIZE: $\frac{1}{2} \times \frac{3}{8}$ $\frac{1}{2} \times \frac{1}{2}$



Dr. 12203117

SIZE: $\frac{1}{2} \times \frac{3}{8}$ $\frac{1}{2} \times \frac{1}{2}$



Dr. 12203118

SIZE: $\frac{1}{2} \times \frac{3}{8}$ $\frac{1}{2} \times \frac{1}{2}$



Dr. 12203111

SIZE: $\frac{1}{2} \times \frac{3}{8}$ $\frac{1}{2} \times \frac{1}{2}$



Dr. 12203112

SIZE: $\frac{1}{2} \times \frac{3}{8}$ $\frac{1}{2} \times \frac{1}{2}$



Dr. 12203119

SIZE: $\frac{1}{2} \times \frac{3}{8}$ $\frac{1}{2} \times \frac{1}{2}$



Dr. 12203120

SIZE: $\frac{1}{2} \times \frac{3}{8}$ $\frac{1}{2} \times \frac{1}{2}$



Dr. 12203113

SIZE: $\frac{1}{2} \times \frac{3}{8}$ $\frac{1}{2} \times \frac{1}{2}$



Dr. 12203114

SIZE: $\frac{1}{2} \times \frac{3}{8}$ $\frac{1}{2} \times \frac{1}{2}$



Dr. 12203121

SIZE: $\frac{1}{2} \times \frac{3}{8}$ $\frac{1}{2} \times \frac{1}{2}$



Dr. 12203122

SIZE: $\frac{1}{2} \times \frac{3}{8} \times \frac{3}{8}$
 $\frac{1}{2} \times \frac{1}{2} \times \frac{1}{2}$



Dr. 12203115

SIZE: $\frac{1}{2} \times \frac{3}{8}$ $\frac{1}{2} \times \frac{1}{2}$



Dr. 12203116

SIZE: $\frac{1}{2} \times \frac{3}{8}$ $\frac{1}{2} \times \frac{1}{2}$



Dr. 12203123

SIZE: $\frac{1}{2} \times \frac{3}{8}$ $\frac{1}{2} \times \frac{1}{2}$



Dr. 12203124

SIZE: $\frac{1}{2} \times \frac{3}{8}$ $\frac{1}{2} \times \frac{1}{2}$



Dr. 12203125

SIZE: $\frac{1}{2} \times \frac{1}{2}$ $\frac{1}{2} \times \frac{3}{4}$



Dr. 12203126

SIZE: $\frac{1}{2} \times \frac{1}{2}$ $\frac{1}{2} \times \frac{3}{4}$



Dr. 12203127

SIZE: $\frac{1}{2} \times \frac{1}{2}$ $\frac{1}{2} \times \frac{3}{4}$



Dr. 12203128

SIZE: $\frac{1}{2} \times \frac{3}{8}$ $\frac{1}{2} \times \frac{1}{2}$



Dr. 12203129

SIZE: $\frac{1}{2} \times \frac{1}{2}$ x10mm
 $\frac{1}{2} \times \frac{3}{4}$ x10mm



Dr. 12203130

SIZE: $\frac{1}{2} \times \frac{3}{8}$ $\frac{1}{2} \times \frac{1}{2}$



Dr. 12203131

SIZE: $\frac{1}{2} \times \frac{3}{8}$ $\frac{1}{2} \times \frac{1}{2}$

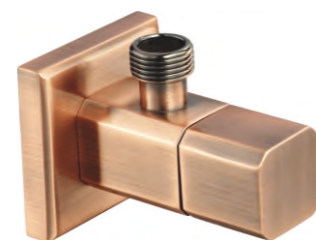

Dr. 12203132

SIZE: $\frac{1}{2} \times \frac{3}{8}$ $\frac{1}{2} \times \frac{1}{2}$



Dr. 12203133

SIZE: $\frac{1}{2} \times \frac{1}{2}$ x10mm
 $\frac{1}{2} \times \frac{3}{4}$ x10mm



Dr. 12203134

SIZE: $\frac{1}{2} \times \frac{1}{2}$ x10mm
 $\frac{1}{2} \times \frac{3}{4}$ x10mm



Dr. 12203135

SIZE: $\frac{1}{2} \times \frac{3}{4}$



Dr. 12203136

SIZE: $\frac{1}{2} \times \frac{1}{2}$ $\frac{1}{2} \times \frac{3}{4}$



Dr. 12203137

SIZE: $\frac{1}{2} \times \frac{1}{2}$ $\frac{1}{2} \times \frac{3}{4}$



Dr. 12203138

SIZE: $\frac{1}{2} \times \frac{1}{2}$ $\frac{1}{2} \times \frac{3}{4}$



Dr. 12203139

SIZE: $\frac{1}{2} \times \frac{1}{2}$ $\frac{1}{2} \times \frac{3}{4}$



Dr. 12203140

SIZE: $\frac{1}{2} \times \frac{1}{2}$ $\frac{1}{2} \times \frac{3}{4}$



Dr. 12203141

SIZE: $\frac{1}{2}$ " x $\frac{1}{2}$ "



Dr. 12203142

SIZE: $\frac{1}{2}$ " x $\frac{1}{2}$ "



Dr. 12203149

SIZE: $\frac{1}{2}$ " x $\frac{1}{2}$ " x $\frac{1}{2}$ "



Dr. 12203150

SIZE: $\frac{3}{4}$ " x $\frac{3}{4}$ " x $\frac{3}{4}$ "



Dr. 12203143

SIZE: $\frac{1}{2}$ " x $\frac{1}{2}$ " x $\frac{1}{2}$ "



Dr. 12203144

SIZE: $\frac{1}{2}$ " x $\frac{1}{2}$ " x $\frac{1}{2}$ "



Dr. 12203151

SIZE: $\frac{1}{2}$ " x $\frac{1}{2}$ " x $\frac{3}{4}$ "



Dr. 12203152

SIZE: $\frac{1}{2}$ " x $\frac{1}{2}$ " x $\frac{3}{4}$ "



Dr. 12203145

SIZE: $\frac{1}{2}$ " x $\frac{3}{4}$ "



Dr. 12203146

SIZE: $\frac{1}{2}$ " x $\frac{1}{2}$ "



Dr. 12203153

SIZE: $\frac{1}{2}$ " x $\frac{1}{2}$ " x $\frac{1}{2}$ "



Dr. 12203154

SIZE: $\frac{1}{2}$ " x $\frac{1}{2}$ " x $\frac{1}{2}$ "



Dr. 12203147

SIZE: $\frac{1}{2}$ " x 10mm



Dr. 12203148

SIZE: $\frac{1}{2}$ " x $\frac{1}{2}$ "



Dr. 12203155

SIZE: $\frac{1}{2}$ " x $\frac{3}{8}$ " x $\frac{1}{2}$ " x $\frac{1}{2}$ " x $\frac{1}{2}$ " x $\frac{3}{4}$ "



Dr. 12203156

SIZE: $\frac{1}{2}$ " x $\frac{3}{4}$ "



Dr. 12203157

SIZE: $\frac{1}{2} \times \frac{3}{8}$ $\frac{1}{2} \times \frac{1}{2}$ $\frac{1}{2} \times \frac{3}{4}$



Dr. 12203158

SIZE: $\frac{1}{2}$ x 10mm



Dr. 12203165

SIZE: $\frac{1}{2} \times \frac{3}{8}$ $\frac{1}{2} \times \frac{1}{2}$ $\frac{1}{2} \times \frac{3}{4}$



Dr. 12203166

SIZE: $\frac{1}{2} \times \frac{3}{8}$ $\frac{1}{2} \times \frac{1}{2}$ $\frac{1}{2} \times \frac{3}{4}$



Dr. 12203159

SIZE: $\frac{1}{2}$ x 10mm x 10mm



Dr. 12203160

SIZE: $\frac{1}{2}$ x 10mm



Dr. 12203167

SIZE: $\frac{1}{2} \times \frac{3}{8}$ $\frac{1}{2} \times \frac{1}{2}$ $\frac{1}{2} \times \frac{3}{4}$



Dr. 12203168

SIZE: $\frac{1}{2} \times \frac{3}{8}$ $\frac{1}{2} \times \frac{1}{2}$ $\frac{1}{2} \times \frac{3}{4}$



Dr. 12203161

SIZE: $\frac{1}{2} \times \frac{3}{8}$ $\frac{1}{2} \times \frac{1}{2}$ $\frac{1}{2} \times \frac{3}{4}$



Dr. 12203162

SIZE: $\frac{1}{2}$ x 10mm



Dr. 12203169

SIZE: $\frac{1}{2}$ x 10mm



Dr. 12203170

SIZE: $\frac{1}{2}$ x 10mm



Dr. 12203163

SIZE: $\frac{1}{2} \times \frac{3}{8}$ $\frac{1}{2} \times \frac{1}{2}$ $\frac{1}{2} \times \frac{3}{4}$



Dr. 12203164

SIZE: $\frac{1}{2}$ x 10mm



Dr. 12203171

SIZE: $\frac{1}{2} \times \frac{3}{8}$ $\frac{1}{2} \times \frac{1}{2}$ $\frac{1}{2} \times \frac{3}{4}$



Dr. 12203172

SIZE: $\frac{1}{2} \times \frac{3}{8}$ $\frac{1}{2} \times \frac{1}{2}$ $\frac{1}{2} \times \frac{3}{4}$



Dr. 12203173

SIZE: $\frac{1}{2}$ " x 10mm



Dr. 12203174

SIZE: $\frac{1}{2}$ " x 10mm



Dr. 12203175

SIZE: $\frac{1}{2}$ " x 10mm



Dr. 12203176

SIZE: $\frac{1}{2}$ " x $\frac{3}{4}$ "



Dr. 12203177

SIZE: $\frac{1}{2}$ " x 10mm



Dr. 12203178

SIZE: $\frac{1}{2}$ " x 10mm



Dr. 12203179

SIZE: $\frac{1}{2}$ " x 10mm



Dr. 12203180

SIZE: $\frac{1}{2}$ " x 10mm x 10mm





Dr. 12705101

SIZE: $\frac{1}{2}$ " $\frac{3}{4}$ " 1" $1\frac{1}{4}$ " $1\frac{1}{2}$ " 2"



Dr. 12705102

SIZE: $\frac{1}{2}$ " $\frac{3}{4}$ " 1" $1\frac{1}{4}$ " $1\frac{1}{2}$ " 2"



Dr. 12705103

SIZE: $\frac{3}{8}$ " $\frac{1}{2}$ "



Dr. 12705104

SIZE: $\frac{3}{8}$ " $\frac{1}{2}$ "



Dr. 12705105

SIZE: $\frac{1}{2}$ " $\frac{3}{4}$ " 1"



Dr. 12705106

SIZE: $\frac{1}{2}$ " $\frac{3}{4}$ " 1" $1\frac{1}{4}$ " $1\frac{1}{2}$ " 2"



Dr. 12705107

SIZE: $\frac{3}{8}$ " $\frac{1}{2}$ " $\frac{3}{4}$ "



Dr. 12705108

SIZE: $\frac{3}{8}$ " $\frac{1}{2}$ " $\frac{3}{4}$ "



Dr. 12705109

SIZE: $\frac{1}{2}$ "



Dr. 12705110

SIZE: $\frac{1}{2}$ "



Dr. 12705111

SIZE: $\frac{3}{8}$ " $\frac{1}{2}$ " $\frac{3}{4}$ "



Dr. 12705112

SIZE: $\frac{1}{2}$ " $\frac{3}{4}$ " 1" $1\frac{1}{4}$ " $1\frac{1}{2}$ " 2"



Dr. 12705113

SIZE: $\frac{1}{2}$ " $\frac{3}{4}$ " 1" $1\frac{1}{4}$ " $1\frac{1}{2}$ " 2"



Dr. 12705114

SIZE: $\frac{1}{2}$ " $\frac{3}{4}$ " 1" $1\frac{1}{4}$ " $1\frac{1}{2}$ " 2"



Dr. 12705115

SIZE: $\frac{1}{2}$ " $\frac{3}{4}$ " 1" $1\frac{1}{4}$ " $1\frac{1}{2}$ " 2"



Dr. 12705116

SIZE: $\frac{1}{2}$ " $\frac{3}{4}$ " 1" $1\frac{1}{4}$ " $1\frac{1}{2}$ " 2"



Dr. 12705117

SIZE: $\frac{1}{2}$ "



Dr. 12705118

SIZE: $\frac{1}{2}$ " $\frac{3}{4}$ "



Dr. 12705119

SIZE: $\frac{1}{2}$ "



Dr. 12705120

SIZE: $\frac{1}{2}$ "





Dr. 12106101

SIZE: $\frac{1}{2}$ " $\frac{3}{4}$ " 1" $1\frac{1}{4}$ " $1\frac{1}{2}$ "
2" $2\frac{1}{2}$ " 3" 4"



Dr. 12106102

SIZE: $\frac{1}{2}$ " $\frac{3}{4}$ " 1" $1\frac{1}{4}$ " $1\frac{1}{2}$ "
2" $2\frac{1}{2}$ " 3" 4"



Dr. 12106109

SIZE: $\frac{1}{2}$ " $\frac{3}{4}$ " 1"



Dr. 12106110

SIZE: $\frac{1}{2}$ " $\frac{3}{4}$ " 1"



Dr. 12106103

SIZE: $\frac{1}{2}$ " $\frac{3}{4}$ " 1" $1\frac{1}{4}$ " $1\frac{1}{2}$ "
2" $2\frac{1}{2}$ " 3" 4"



Dr. 12106104

SIZE: $\frac{1}{2}$ " $\frac{3}{4}$ " 1" $1\frac{1}{4}$ " $1\frac{1}{2}$ "
2" $2\frac{1}{2}$ " 3" 4"



Dr. 12106111

SIZE J15 18 22



Dr. 12106112

SIZE: $\frac{1}{2}$ " $\frac{3}{4}$ " 1"



Dr. 12106105

SIZE: $\frac{1}{2}$ " $\frac{3}{4}$ " 1" $1\frac{1}{4}$ " $1\frac{1}{2}$ "
2" $2\frac{1}{2}$ " 3" 4"



Dr. 12106106

SIZE J15 18 22



Dr. 12106113

SIZE: $\frac{1}{2}$ " $\frac{3}{4}$ " 1"



Dr. 12106114

SIZE: $\frac{1}{2}$ " $\frac{3}{4}$ " 1"



Dr. 12106107

SIZE J15 18 22



Dr. 12106108

SIZE J15 18 22



Dr. 12106115

SIZE: $\frac{1}{2}$ " $\frac{3}{4}$ " 1"



Dr. 12106116

SIZE: $\frac{1}{2}$ " $\frac{3}{4}$ " 1"

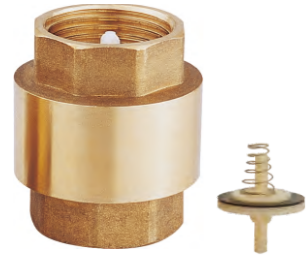

Dr. 12606117

SIZE: $\frac{1}{2}$ " $\frac{3}{4}$ " 1" $1\frac{1}{4}$ " $1\frac{1}{2}$ "
2" $2\frac{1}{2}$ " 3" 4"



Dr. 12606118

SIZE: $\frac{1}{2}$ " $\frac{3}{4}$ " 1" $1\frac{1}{4}$ " $1\frac{1}{2}$ "
2" $2\frac{1}{2}$ " 3" 4"



Dr. 12606119

SIZE: $\frac{1}{2}$ " $\frac{3}{4}$ " 1" $1\frac{1}{4}$ " $1\frac{1}{2}$ "
2" $2\frac{1}{2}$ " 3" 4"



Dr. 12606120

SIZE: $\frac{1}{2}$ " $\frac{3}{4}$ " 1" $1\frac{1}{4}$ " $1\frac{1}{2}$ "
2" $2\frac{1}{2}$ " 3" 4"



Dr. 12606121

SIZE: $\frac{1}{2}$ " $\frac{3}{4}$ " 1" $1\frac{1}{4}$ " $1\frac{1}{2}$ "
2" $2\frac{1}{2}$ " 3" 4"



Dr. 12606122

SIZE: $\frac{1}{2}$ " $\frac{3}{4}$ " 1" $1\frac{1}{4}$ " $1\frac{1}{2}$ "
2" $2\frac{1}{2}$ " 3" 4"



Dr. 12606123

SIZE: $\frac{1}{2}$ " $\frac{3}{4}$ " 1"



Dr. 12606124

SIZE: $\frac{1}{2}$ " $\frac{3}{4}$ " 1" $1\frac{1}{4}$ " $1\frac{1}{2}$ "
2" $2\frac{1}{2}$ " 3" 4"





Dr. 12809101

SIZE: $\frac{1}{2}$ " x $\frac{1}{2}$ "



Dr. 12809102

SIZE: $\frac{1}{2}$ " x $\frac{1}{2}$ "



Dr. 12809103

SIZE: $\frac{1}{2}$ " x $\frac{1}{2}$ "

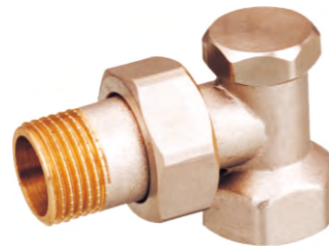

Dr. 12809104

SIZE: $\frac{1}{2}$ " x $\frac{1}{2}$ "



Dr. 12809105

SIZE: $\frac{1}{2}$ " x $\frac{1}{2}$ "



Dr. 12809106

SIZE: $\frac{1}{2}$ " x $\frac{1}{2}$ "



Dr. 12809107

SIZE: 15 x $\frac{1}{2}$ "



Dr. 12809108

SIZE: 15 x $\frac{1}{2}$ "



Dr. 12809117

SIZE: $\frac{1}{2}$ " $\frac{3}{4}$ " 3"



Dr. 12809118

SIZE: $\frac{1}{2}$ " $\frac{3}{4}$ "



Dr. 12809119

SIZE: $\frac{1}{2}$ " $\frac{3}{4}$ " 1"



Dr. 12809120

SIZE: $\frac{1}{2}$ " $\frac{3}{4}$ "



Dr. 12809121

SIZE: $\frac{1}{2}$ " $\frac{3}{4}$ " 1"



Dr. 12809122

SIZE: $\frac{1}{2}$ " $\frac{3}{4}$ " 1"



Dr. 12809123

SIZE: $\frac{1}{2}$ "



Dr. 12809124

SIZE: $\frac{1}{2}$ " $\frac{3}{4}$ " 1"



Dr. 12909109

SIZE: $\frac{3}{8}$ " $\frac{1}{2}$ "



Dr. 12909110

SIZE: $\frac{3}{8}$ " $\frac{1}{2}$ "



Dr. 12909111

SIZE: $\frac{3}{8}$ " $\frac{1}{2}$ "



Dr. 12909112

SIZE: $\frac{3}{8}$ " $\frac{1}{2}$ "



Dr. 12909113

SIZE: $\frac{1}{2}$ "



Dr. 12909114

SIZE: $\frac{1}{2}$ "



Dr. 12909115

SIZE: 2"



Dr. 12909116

SIZE: $\frac{1}{2}$ "



Dr. 12007101

SIZE: $\frac{3}{8}$ " $\frac{1}{2}$ " $\frac{3}{4}$ " 1"



Dr. 12007102

SIZE: $\frac{3}{8}$ " $\frac{1}{2}$ " $\frac{3}{4}$ " 1"



Dr. 12007103

SIZE: $\frac{3}{8}$ " $\frac{1}{2}$ " $\frac{3}{4}$ " 1"



Dr. 12007104

SIZE: $\frac{3}{8}$ " x $\frac{1}{2}$ " $\frac{1}{2}$ " x $\frac{3}{4}$ " $\frac{3}{4}$ " x 1" 1x $\frac{1}{4}$ "



Dr. 12007105

SIZE: $\frac{3}{8}$ " $\frac{1}{2}$ " $\frac{3}{4}$ " 1"



Dr. 12007106

SIZE: $\frac{3}{8}$ " $\frac{1}{2}$ " $\frac{3}{4}$ " 1"



Dr. 12007107

SIZE: $\frac{3}{8}$ " $\frac{1}{2}$ " $\frac{3}{4}$ " 1"



Dr. 12007108

SIZE: $\frac{3}{8}$ " $\frac{1}{2}$ " $\frac{3}{4}$ " 1"



Dr. 12007109

SIZE: $\frac{1}{2}$ " x $\frac{3}{4}$ " $\frac{3}{4}$ " x 1"



Dr. 12007110

SIZE: $\frac{1}{2}$ " $\frac{3}{4}$ " 1"



Dr. 12007111

SIZE: $\frac{1}{2}$ " $\frac{3}{4}$ " 1"



Dr. 12007112

SIZE: $\frac{1}{2}$ " $\frac{3}{4}$ " 1"



Dr. 12007113
SIZE: $\frac{1}{2}$ " $\frac{3}{4}$ " 1"



Dr. 12007114
SIZE: $\frac{1}{2}$ " $\frac{3}{4}$ " 1"



Dr. 12007115
SIZE: $\frac{1}{2}$ " $\frac{3}{4}$ " 1"



Dr. 12007125
SIZE: $\frac{1}{2}$ "x15 $\frac{3}{4}$ "x15 $\frac{1}{2}$ "x18
 $\frac{3}{4}$ "x18 $\frac{1}{2}$ "x22 $\frac{3}{4}$ "x22 1"x22

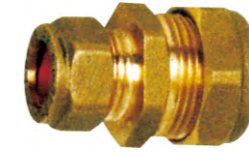

Dr. 12007126
SIZE: J15x8 15x12 18x15 22x15 22x18



Dr. 12007127
SIZE: J15 18 22 28



Dr. 12007116
SIZE: $\frac{1}{2}$ " $\frac{3}{4}$ " 1"



Dr. 12007117
SIZE: $\frac{1}{2}$ " F x $\frac{1}{2}$ "/16 $\frac{3}{4}$ " F x $\frac{1}{2}$ "/16



Dr. 12007118
SIZE: $\frac{1}{2}$ " F x $\frac{1}{2}$ "/16 $\frac{3}{4}$ " F x $\frac{1}{2}$ "/16



Dr. 12007128
SIZE: $\frac{1}{2}$ "x15 $\frac{3}{4}$ "x15 $\frac{1}{2}$ "x18
 $\frac{3}{4}$ "x18 $\frac{1}{2}$ "x22 $\frac{3}{4}$ "x22 1"x22



Dr. 12007129
SIZE: $\frac{1}{2}$ "x15 $\frac{3}{4}$ "x15 $\frac{1}{2}$ "x18
 $\frac{3}{4}$ "x18 $\frac{3}{4}$ "x22 1"x22



Dr. 12007130
SIZE: J15 18 22 28



Dr. 12007119
SIZE: $\frac{1}{2}$ "/16 x $\frac{1}{2}$ " F x $\frac{1}{2}$ "/16 $\frac{3}{4}$ "/18 x $\frac{1}{2}$ " F x $\frac{3}{4}$ "/18



Dr. 12007120
SIZE: $\frac{1}{2}$ "/16 x $\frac{1}{2}$ "/16 $\frac{3}{4}$ "/18 x $\frac{3}{4}$ "/18



Dr. 12007121
SIZE: $\frac{1}{2}$ " x $\frac{1}{2}$ "/16 $\frac{1}{2}$ " x $\frac{3}{4}$ "/18 $\frac{3}{4}$ " x $\frac{1}{2}$ "/16 $\frac{3}{4}$ " x $\frac{3}{4}$ "/18



Dr. 12007131
SIZE: J15x15x22 22x15x22 22x22x28



Dr. 12007132
SIZE: $\frac{1}{2}$ "x15x15 $\frac{1}{2}$ "x22x22 $\frac{3}{4}$ "x22x22



Dr. 12007133
SIZE: $\frac{1}{2}$ "x15x15 $\frac{1}{2}$ "x22x22 $\frac{3}{4}$ "x22x22



Dr. 12007122
SIZE: J15 18 22



Dr. 12007123
SIZE: $\frac{1}{2}$ "/16 x $\frac{1}{2}$ "/16 x $\frac{1}{2}$ "/16 $\frac{3}{4}$ "/18 x $\frac{3}{4}$ "/18 x $\frac{3}{4}$ "/18



Dr. 12007124
SIZE: $\frac{1}{2}$ "x15 $\frac{3}{4}$ "x15 $\frac{1}{2}$ "x18
 $\frac{3}{4}$ "x18 $\frac{1}{2}$ "x22 $\frac{3}{4}$ "x22 1"x22



Dr. 12007134
SIZE: J15x15 22x22 28x28



Dr. 12007135
SIZE: $\frac{1}{2}$ "x15 $\frac{3}{4}$ "x22 1"x28



Dr. 12007136
SIZE: $\frac{1}{2}$ "x15 $\frac{3}{4}$ "x22 1"x28



Dr. 12007137
 SIZE: $\frac{1}{2}$ "x15 $\frac{3}{4}$ "x22 1"x28



Dr. 12007138
 SIZE J15x15 22x22 28x28



Dr. 12007139
 SIZE: $\frac{1}{2}$ "x15 $\frac{3}{4}$ "x22 1"x28



Dr. 12007149
 SIZE: $\frac{1}{2}$ "x16



Dr. 12007150
 SIZE: $\frac{1}{2}$ "x16



Dr. 12007151
 SIZE J16x16x16x16 20x20x20x20



Dr. 12007140
 SIZE: $\frac{1}{2}$ "x16x16 $\frac{3}{4}$ "x20x20 1"x28x28



Dr. 12007141
 SIZE J16x16x16 20x20x20 28x28x28



Dr. 12007142
 SIZE: $\frac{1}{2}$ "x16x16 $\frac{3}{4}$ "x20x20 1"x28x28



Dr. 12007152
 SIZE: $\frac{1}{2}$ "x20 $\frac{3}{4}$ "x25 1"x32



Dr. 12007153
 SIZE J20x20 25x25 32x32



Dr. 12007154
 SIZE: $\frac{1}{2}$ "x20 $\frac{3}{4}$ "x25 1"x32



Dr. 12007143
 SIZE: $\frac{1}{2}$ "x16 $\frac{3}{4}$ "x20 1"x28



Dr. 12007144
 SIZE J16x16 20x20 28x28



Dr. 12007145
 SIZE: $\frac{1}{2}$ "x16 $\frac{3}{4}$ "x20 1"x28



Dr. 12007155
 SIZE: $\frac{1}{2}$ "x20 $\frac{3}{4}$ "x25 1"x32



Dr. 12007156
 SIZE: $\frac{1}{2}$ "x20x20 $\frac{3}{4}$ "x25x25 1"x32x32



Dr. 12007157
 SIZE: $\frac{1}{2}$ "x20 $\frac{3}{4}$ "x25 1"x32



Dr. 12007146
 SIZE: $\frac{1}{2}$ "x16 $\frac{3}{4}$ "x20 1"x28



Dr. 12007147
 SIZE J1/2"x16 3/4"x20 1"x28



Dr. 12007148
 SIZE J16x16 20x20 28x28



Dr. 12007158
 SIZE J $\frac{3}{4}$ " 1" $1\frac{1}{4}$ "



Dr. 12007159
 SIZE J20x20 25x25 32x32



Dr. 12007160
 SIZE: $\frac{1}{2}$ "x20x20 $\frac{3}{4}$ "x25x25 1"x32x32



Dr. 12007161

SIZE: $\frac{1}{2}$ "x10mm $\frac{1}{2}$ "x20mm $\frac{1}{2}$ "x30mm
 $\frac{1}{2}$ "x40mm $\frac{1}{2}$ "x50mm $\frac{1}{2}$ "x60mm



Dr. 12007162

SIZE: $\frac{1}{2}$ "x16 $\frac{3}{4}$ "x16 $\frac{1}{2}$ "x20 $\frac{3}{4}$ "x20
 $\frac{3}{4}$ "x26 1"x26 1"x32



Dr. 12007163

SIZE: $\frac{1}{2}$ "x16 $\frac{3}{4}$ "x16 $\frac{1}{2}$ "x20 $\frac{3}{4}$ "x20
 $\frac{3}{4}$ "x26 1"x26 1"x32



Dr. 12007164

SIZE: $\frac{1}{2}$ "x16 $\frac{3}{4}$ "x16 $\frac{1}{2}$ "x20 $\frac{3}{4}$ "x20
 $\frac{3}{4}$ "x26 1"x26 1"x32



Dr. 12007165

SIZE: J16 20 26 32 16x20 20x26 26x32



Dr. 12007166

SIZE: J16 20 26 32



Dr. 12007167

SIZE: $\frac{1}{2}$ "x16 $\frac{3}{4}$ "x16 $\frac{1}{2}$ "x20 $\frac{3}{4}$ "x20
 $\frac{3}{4}$ "x26 1"x26 1"x32



Dr. 12007168

SIZE: $\frac{1}{2}$ "x16 $\frac{3}{4}$ "x16 $\frac{1}{2}$ "x20 $\frac{3}{4}$ "x20
 $\frac{3}{4}$ "x26 1"x26 1"x32



Dr. 12007169

SIZE: $\frac{1}{2}$ "x16 $\frac{3}{4}$ "x16 $\frac{1}{2}$ "x20 $\frac{3}{4}$ "x20
 $\frac{3}{4}$ "x26 1"x26 1"x32



Dr. 12007170

SIZE: J16 20 26 32



Dr. 12007171

SIZE: $\frac{1}{2}$ "x16 $\frac{1}{2}$ "x20



Dr. 12007172

SIZE: $\frac{1}{2}$ "x16 $\frac{3}{4}$ "x16 $\frac{1}{2}$ "x20 $\frac{3}{4}$ "x20
 $\frac{3}{4}$ "x26 1"x26 1"x32



Dr. 12008101

SIZE: $\frac{3}{4}$ "x(2-5ways) 1"x(2-5ways)



Dr. 12302102

SIZE: $\frac{3}{4}$ "x(2-5ways) 1"x(2-5ways)



Dr. 12008103

SIZE: $\frac{3}{4}$ "x(2-5ways) 1"x(2-5ways)



Dr. 12008104

SIZE: $\frac{3}{4}$ "x(2-5ways) 1"x(2-5ways)



Dr. 12008105

SIZE: $\frac{3}{4}$ "x(2-5ways) 1"x(2-5ways)

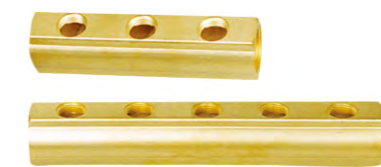

Dr. 12008106

SIZE: $\frac{3}{4}$ "x(2-12ways) 1"x(2-12ways)



Dr. 12008107

SIZE: $\frac{3}{4}$ "x(2-5ways) 1"x(2-5ways)



Dr. 12008108

SIZE: $\frac{3}{4}$ "x(2-5ways) 1"x(2-5ways)